

www.v3s-glass-systems.be



Plinthes
Door rails

ASSA ABLOY



Plinthes
Door rails

Série FRP



Caractéristiques techniques

- Hauteur 100 mm
- Pour verre de 10 et 12 mm
- Montage sans encoche
- Poids maximum 300 kg
- Porte maxi 1400 x 2400 mm
- Montage à l'aide de vis invisible

Technical features

- Height 100 mm
- For 10 and 12 mm thick glass
- No notches needed
- Maximum door weight 300 kg
- Maximum door size 1400 x 2400 mm
- Clamping by using invisible screws

Jeux recommandés. Recommended tolerances.

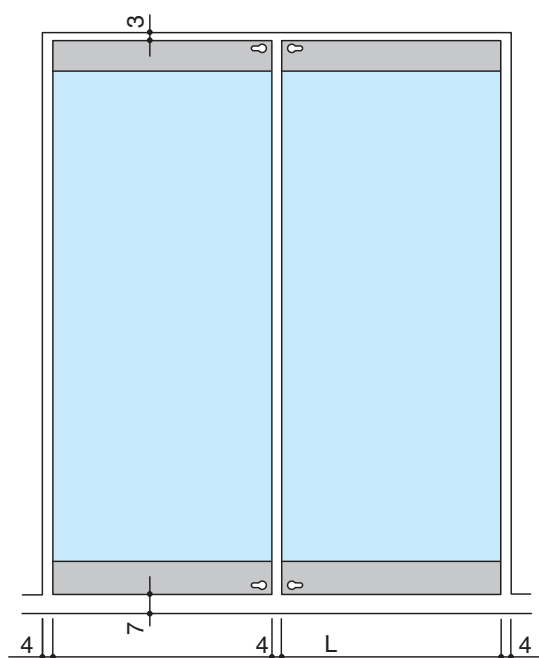

Préparation du verre.

Glass preparation.

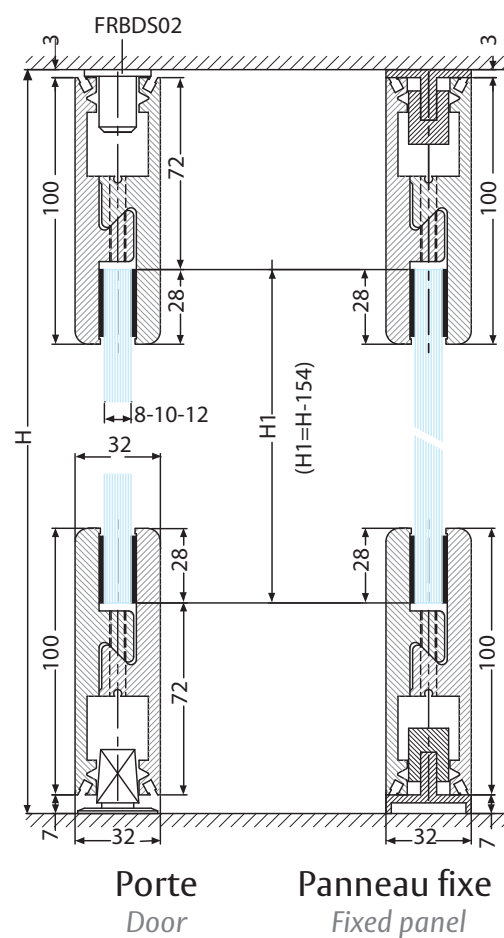



FRBDS02.99

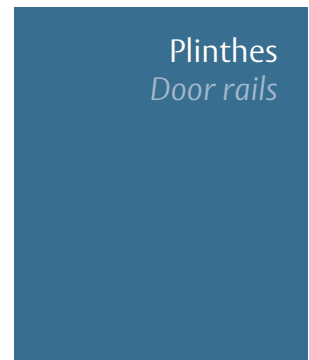
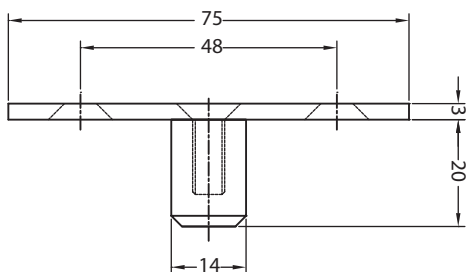

Pivot haut pour plinthe haute FRP02
 Top pivot for top door rail FRP02

FRP02B

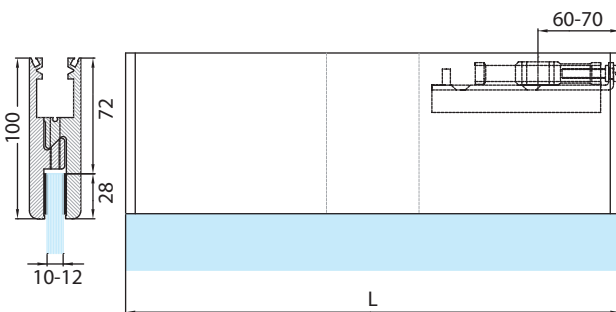
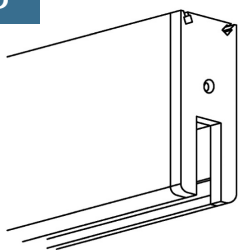

Références / References

Plinthe supérieure hauteur 100 mm avec insert et embouts
 Top rail 100 mm high with pivot block and end caps

Aluminium anodisé Argent Brossé / Brushed anodised alu. silver
 Aluminium anodisé Aninox / Brushed anodised alu. aninox



Pour verre de 10 mm
 For 10 mm glass

FRP02B/10.12

FRP02B/10.36



Pour verre de 12 mm
 For 12 mm glass

FRP02B/12.12

FRP02B/12.36

FRP02BL

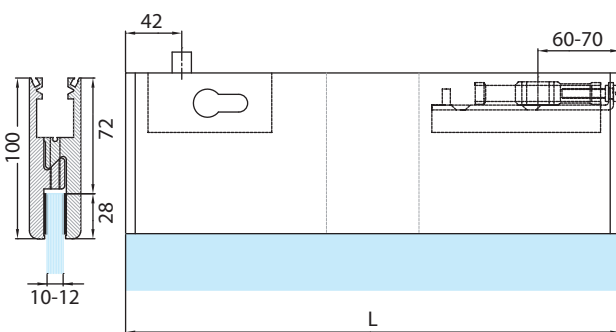
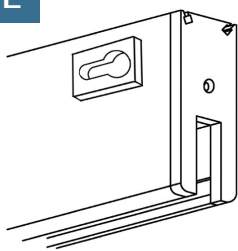

Références / References

Plinthe supérieure hauteur 100 mm avec insert, embouts, serrure et cylindre
 Top rail 100 mm high with pivot block, end caps, lock and cylinder

Aluminium anodisé Argent Brossé / Brushed anodised alu. silver
 Aluminium anodisé Aninox / Brushed anodised alu. aninox



Pour verre de 10 mm
 For 10 mm glass

FRP02BL/10.12

FRP02BL/10.36



Pour verre de 12 mm
 For 12 mm glass

FRP02BL/12.12

FRP02BL/12.36



Plinthes
Doorrails



FRP020

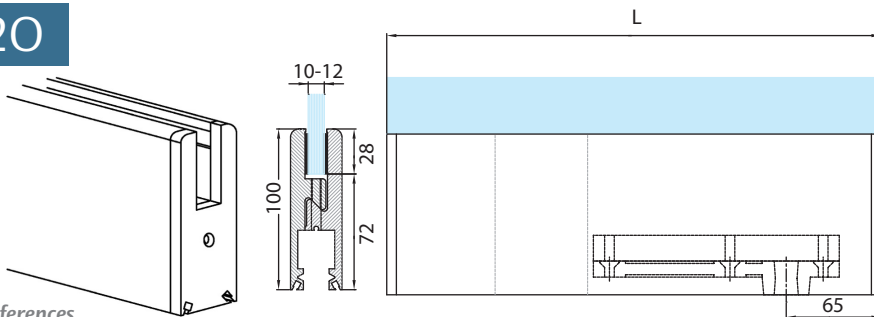

Références / References

  Plinthe inférieure hauteur 100 mm avec insert carré italien et embouts
Bottom rail 100 mm high with Italian square spindle and end caps

 Aluminium anodisé Argent Brossé
Brushed anodised alu. silver

 Aluminium anodisé Aninox
Brushed anodised alu. aninox

 Pour verre de 10 mm
For 10 mm glass

FRP020/10.12 FRP020/10.36



 Pour verre de 12 mm
For 12 mm glass

FRP020/12.12 FRP020/12.36

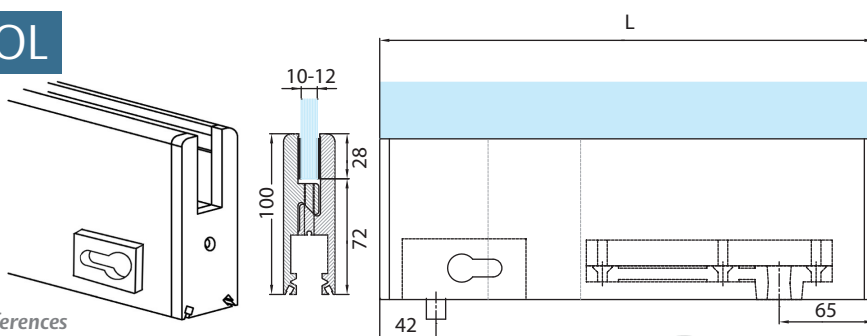
FRP020L



Références / References

  Plinthe inférieure hauteur 100 mm avec insert carré italien, embouts, serrure et cylindre
Bottom rail 100 mm high with Italian square spindle and end caps, lock and cylinder

 Aluminium anodisé Argent Brossé
Brushed anodised alu. silver

 Aluminium anodisé Aninox
Brushed anodised alu. aninox

 Pour verre de 10 mm
For 10 mm glass

FRP020L/10.12 FRP020L/10.36

 Pour verre de 12 mm
For 12 mm glass

FRP020L/12.12 FRP020L/12.36

FRP07B

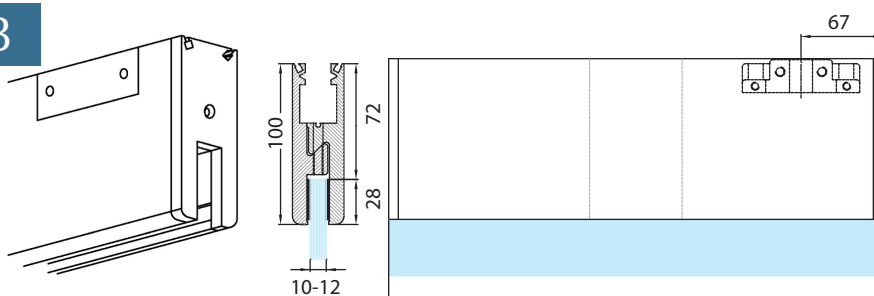

Références / References

Plinthe supérieure hauteur 100 mm avec insert pour ferme porte encastré série 5600 et embouts
Top rail 100 mm high with pivot block for closers series 5600 and end caps

 Aluminium anodisé Argent Brossé
Brushed anodised alu. silver

 Aluminium anodisé Aninox
Brushed anodised alu. aninox

 Pour verre de 10 mm
For 10 mm glass

FRP07B/10.12 FRP07B/10.36

 Pour verre de 12 mm
For 12 mm glass

FRP07B/12.12 FRP07B/12.36



Plinthes
Doorrails

FRP07BL

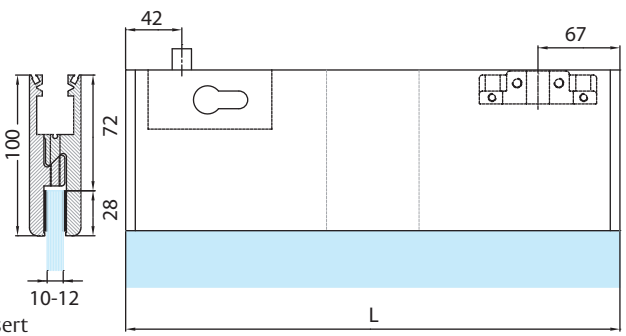
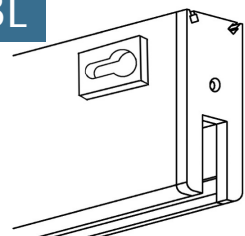

Références / References

Plinthe supérieure hauteur 100 mm avec insert pour ferme porte encastré série 5600 et embouts
Top rail 100 mm high with pivot block for closers series 5600 and end caps



Pour verre de 10 mm
For 10 mm glass

FRP07BL/10.12

FRP07BL/10.36



Pour verre de 12 mm
For 12 mm glass

FRP07BL/12.12

FRP07BL/12.36

FRP06B

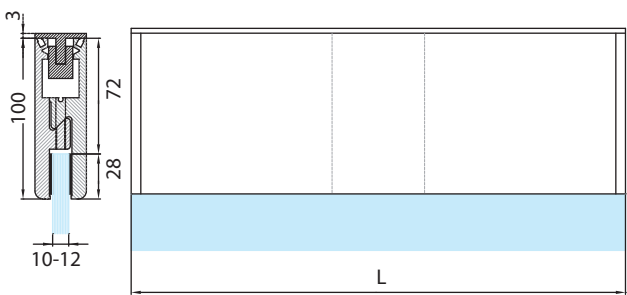
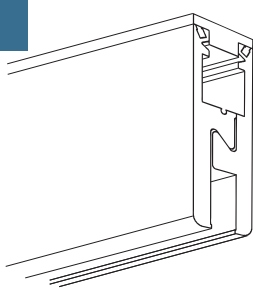

Références / References

Plinthe haute sans embout, hauteur 100 mm pour volumes fixes + Profilé supérieur de remplissage 3 mm
Top rail 100 mm high for fixed panels, without end caps + 3 mm Top filler profile



Pour verre de 10 mm
For 10 mm glass

FRP06B/10.12

FRP06B/10.36



Pour verre de 12 mm
For 12 mm glass

FRP06B/12.12

FRP06B/12.36

FRP06O

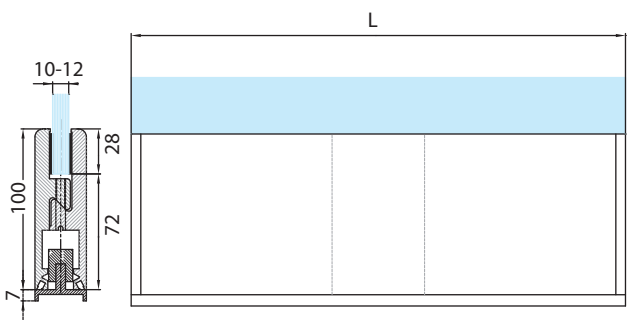
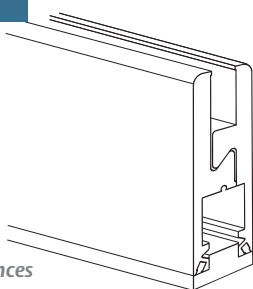

Références / References

Plinthe basse sans embout, hauteur 100 mm pour volumes fixes + Profilé inférieur de remplissage 7 mm
Bottom rail 100 mm high for fixed panels, without end caps + 7 mm bottom filler profile



Pour verre de 10 mm
For 10 mm glass

FRP06O/10.12

FRP06O/10.36



Pour verre de 12 mm
For 12 mm glass

FRP06O/12.12

FRP06O/12.36



Plinthes
Door rails

FRE14.99

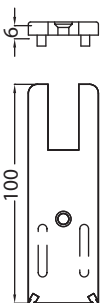

Références / References

Embout noir avec vis
Black end cap including screw

FRE14.73

FRE14.74



FRB**

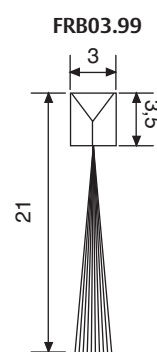
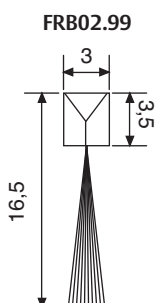
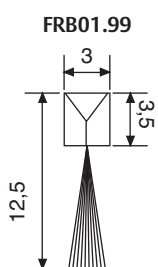

Références / References

Brosse d'étanchéité longueur 2 m pour jeu de 7 mm
Brushes length 2m for a tolerance of 7 mm

FRB01.99

Brosse d'étanchéité longueur 2 m pour jeu de 9 mm
Brushes length 2m for a tolerance of 9 mm

FRB02.99

Brosse d'étanchéité longueur 2 m pour jeu de 13 mm
Brushes length 2m for a tolerance of 13 mm

FRB03.99



• Technische dienst
• Verkeersdienst 14.2
• Informatica
• Personeelsdienst
• Bibliotheek
• Burgemeester
• Secretaris
• Wijkwaker
• Financiële
• Assistent
• Opleiding





Profils Profiles

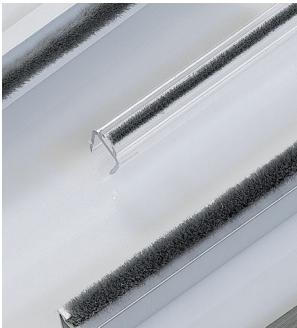

Caractéristiques techniques

- Pour verre de 8, 10, 12, 15 et 19 mm
- Montage sans encoche

Technical features

- For 8, 10, 12, 15 and 19 mm thick glass
- No notches needed

2810.xx.L3000

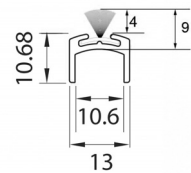

Références / References

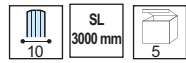

Joint U avec brosse centrale
U profile with brush



2810.12.L3000 **2810.36.L3000**

2812.xx.L3000

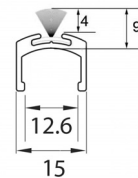

Références / References

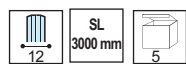

Joint U avec brosse centrale
U profile with brush



2812.12.L3000 **2812.36.L3000**





2809.**.4

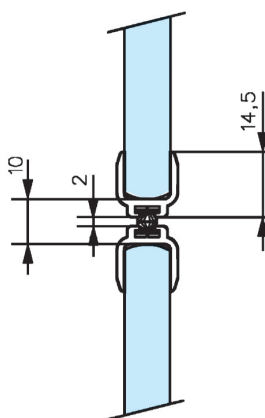

Références / References

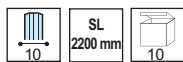

SL
2200 mm

10



Translucide
Translucent

Joint translucide avec brosse axée
Translucent sealing strip with central brush

2809.66.4

2810.10.*

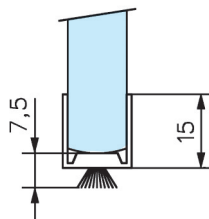
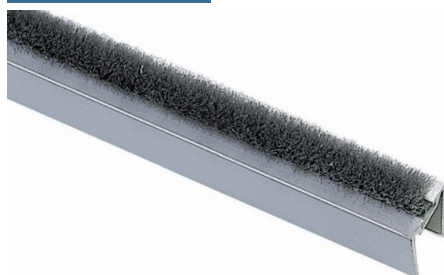

Références / References

Joint aluminium avec brosse axée
Aluminium sealing strip with central brush



Aluminium anodisé Argent satiné
Satin anodised alu. silver

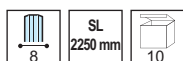

SL
2250 mm

10

Pour verre de 8 mm
For 8 mm glass

2810.10.3

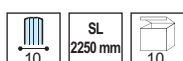

SL
2250 mm

10

Pour verre de 10 mm
For 10 mm glass

2810.10.4

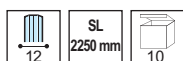

SL
2250 mm

10

Pour verre de 12 mm
For 12 mm glass

2810.10.5

2811.10.*

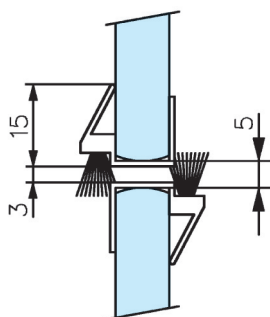
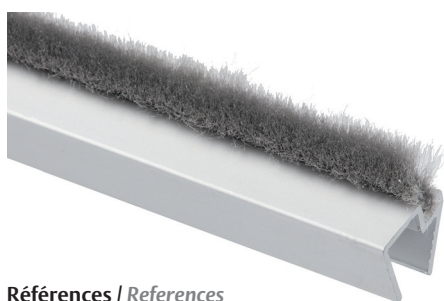

Références / References

Joint aluminium avec brosse déportée
Aluminium sealing strip with off set brush



Aluminium anodisé Argent satiné
Satin anodised alu. silver



SL
2250 mm

10

Pour verre de 8 mm
For 8 mm glass

2811.10.3

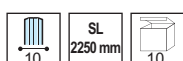

SL
2250 mm

10

Pour verre de 10 mm
For 10 mm glass

2811.10.4





Profils
Profiles

2811

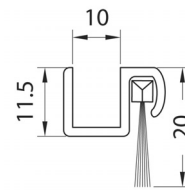
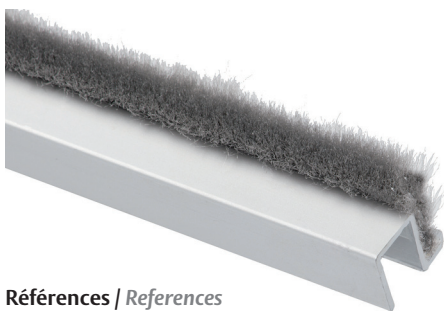

Références / References

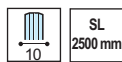

Aluminium anodisé Argent Brossé
Brushed anodised alu. silver

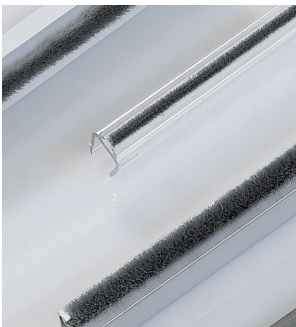

Joint aluminium U avec brosse axée
Aluminium U sealing strip with off set brush

2811.12

FRKB01.99

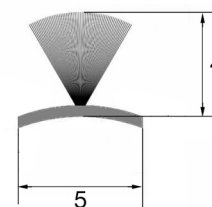

Brosse autocollante pour toutes les épaisseurs de verre - le mètre
Brush self-adhesive for all glass thicknesses - per metre

28131



Références / References

Aluminium anodisé Argent Brossé
Brushed anodised alu. silver

Joint aluminium avec brosse autocollante longueur 1030mm pour toutes les épaisseurs de verre
Aluminium brush profile self-adhesive length 1030mm for all glass thicknesses

28131.12

• Livré avec 2 embouts

• Supplied with 2 end caps





2813

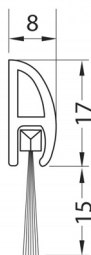

Aluminium anodisé Argent Brossé
Brushed anodised alu. silver

Références / References

Joint aluminium avec brosse autocollante longueur 2500 mm pour toutes les épaisseurs de verre
Aluminium brush profile self-adhesive length 2500 mm for all glass thicknesses

2813.12

• Livré avec 2 embouts

• Supplied with 2 end caps

2813L.99



Références / References

Embout gauche pour joint brosse 2813
Cover cap Left for brush profile 2813

2813R.99



Références / References

Embout droite pour joint brosse 2813
Cover cap Right for brush profile 2813

Profils
Profiles





Profils
Profiles

U151515

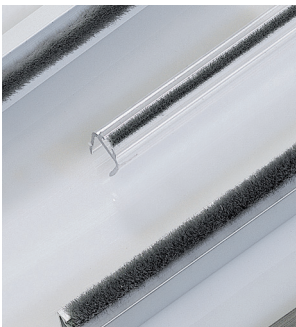

Références / References

SL Profil U 15x15x15x2mm (le mètre)
6000 mm U-profile 15x15x15x2mm (per metre)

- 
 Aluminium anodisé Argent Brossé
Brushed anodised alu. silver
- 
 Aluminium anodisé Aninox
Brushed anodised alu. aninox
- 
 Laqué blanc 9010
Lacquered white RAL 9010

U151515.12 **U151515.36** **U151515.51**

U202020



Références / References

SL Profil U 20x20x20x2mm (le mètre)
6000 mm U-profile 20x20x20x2mm (per metre)

- 
 Aluminium anodisé Argent Brossé
Brushed anodised alu. silver
- 
 Aluminium anodisé Aninox
Brushed anodised alu. aninox

U202020.12 **U202020.36**

U302030



Références / References

SL Profil U 30x20x30x2mm (le mètre)
6000 mm U-profile 30x20x30x2mm (per metre)

- 
 Aluminium anodisé Argent Brossé
Brushed anodised alu. silver
- 
 Aluminium anodisé Aninox
Brushed anodised alu. aninox

U302030.12 **U302030.36**





Profils
Profiles

Profils U et L décor alu poli brillant

U and L profiles Polished aluminium finish



Alu poli brillant
Polished aluminium

Références / References

Profil U 15x15x15x2 mm largeur intérieure 11 mm longueur de 3000 mm <i>U-profile 15x15x15x2 mm 11 mm inside width 3000 mm length</i>	U151515.13
Profil U 20x12x20x1,5 mm largeur intérieure 9 mm longueur de 3000 mm <i>U-profile 20x12x20x1,5 mm 9 mm inside width 3000 mm length</i>	U201220.13
Profil U 20x15x20x2 mm largeur intérieure 11 mm longueur de 3000 mm <i>U-profile 20x15x20x2 mm 11 mm inside width 3000 mm length</i>	U201520.13
Profil U 20x17x20x2 mm largeur intérieure 13 mm longueur de 3000 mm <i>U-profile 20x17x20x2 mm 13 mm inside width 3000 mm length</i>	U201720.13
Profil U 20x20x20x2 mm largeur intérieure 16 mm longueur de 3000 mm <i>U-profile 20x20x20x2 mm 16 mm inside width 3000 mm length</i>	U202020.13
Profil U 30x20x30x2 mm largeur intérieure 16 mm longueur de 3000 mm <i>U-profile 30x20x30x2 mm 16 mm inside width 3000 mm length</i>	U302030.13
Profil U 40x20x40x2 mm largeur intérieure 16 mm longueur de 3000 mm <i>U-profile 40x20x40x2 mm 16 mm inside width 3000 mm length</i>	U402040.13
Profil L 15x15x2 mm longueur de 3000 mm <i>L-profile 15x15x2 mm 3000 mm length</i>	L1515.13
Profil L 20x20x2 mm longueur de 3000 mm <i>L-profile 20x20x2 mm 3000 mm length</i>	L2020.13
Profil L 25x25x2 mm longueur de 3000mm <i>L-profile 25x25x2 mm 3000 mm length</i>	L2525.13

Quantités minimum de commande par référence = 5 longueurs

Quantités de lots par référence = 5 longueurs

Minimum quantity per order and per reference = 5 lengths

Sold in packs per reference = 5 lengths



Profils
Profiles

KL001

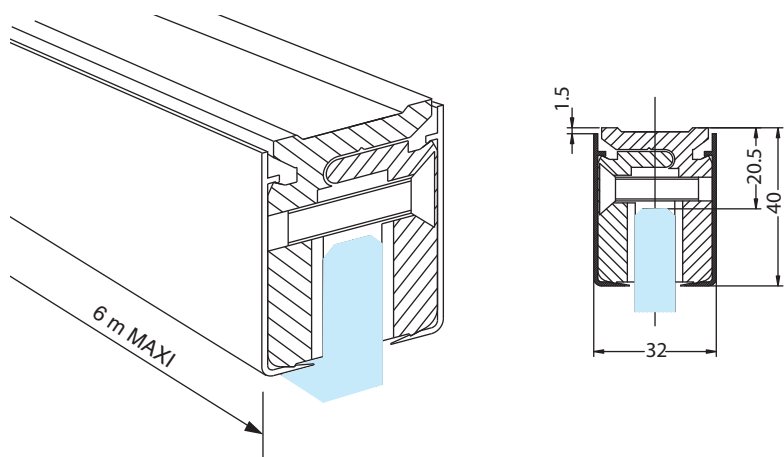

Verre suspendu poids maxi : 40 kg par mètre courant
Hanging glass maximum weight : 40 kg per running metre

Références / References



Profil de serrage pour panneaux fixes avec caches, sans encoches (le mètre)
Glass clamp profile incl. covers, no notch (per meter)



	Pour verre de 8 mm <i>For 8 mm glass</i>	KL001/08.12	KL001/08.36
	Pour verre de 10 mm <i>For 10 mm glass</i>	KL001/10.12	KL001/10.36
	Pour verre de 12 mm <i>For 12 mm glass</i>	KL001/12.12	KL001/12.36

KL002

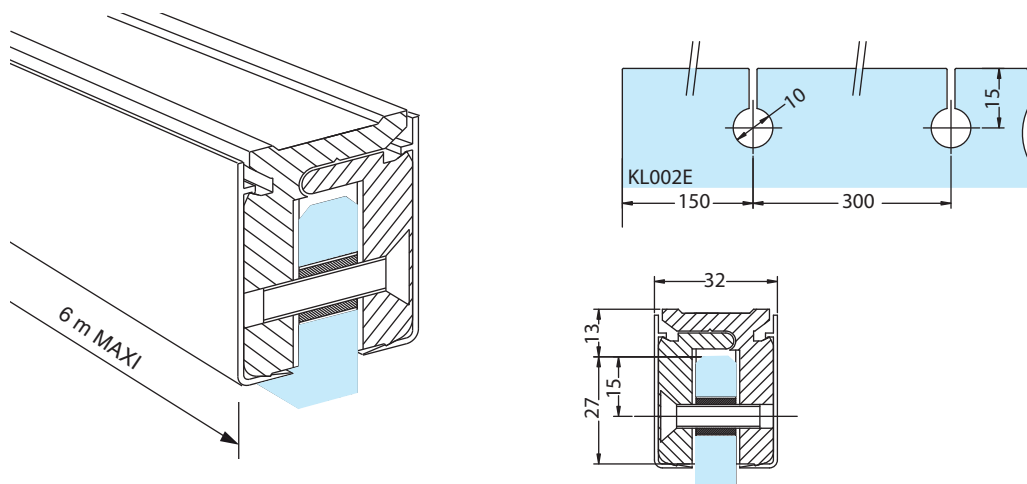

Verre suspendu poids maxi : 40 kg par mètre courant (le mètre)
Hanging glass maximum weight : 40 kg per running metre (per meter)

Références / References



Profil de serrage avec caches pour panneaux fixes avec trous (le mètre)
Glass clamp profile incl. covers for glass with holes notches (per meter)



	Pour verre de 8 mm <i>For 8 mm glass</i>	KL002/08.12	KL002/08.36
	Pour verre de 10 mm <i>For 10 mm glass</i>	KL002/10.12	KL002/10.36

KL003

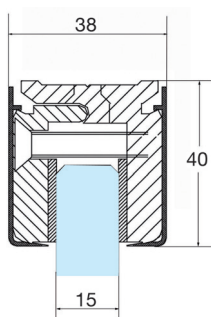
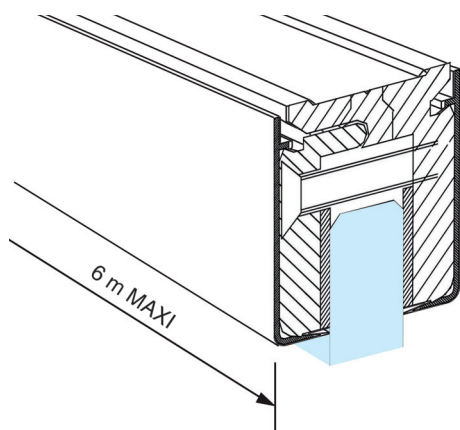

Verre suspendu poids maxi : 40 kg par mètre courant.
Hanging glass maximum weight : 40 kg per running metre

Références / References

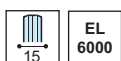

EL
6000



Aluminium anodisé Argent Brossé
Brushed anodised alu. silver



Aluminium anodisé Aninox
Brushed anodised alu. aninox

Profil de serrage pour panneaux fixes avec caches (le mètre)
Glass clamp profile incl. covers (per meter)

KL003.12

KL003.36

KL005

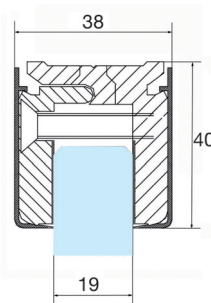
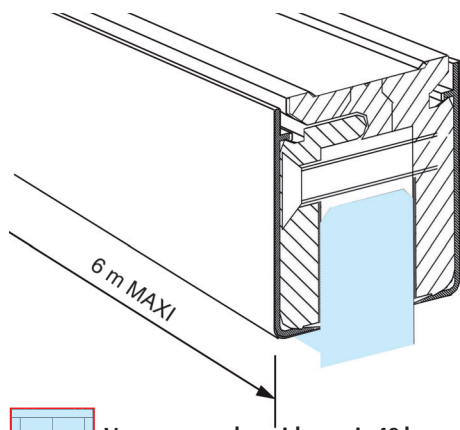

Verre suspendu poids maxi : 40 kg par mètre courant.
Hanging glass maximum weight : 40 kg per running metre

Références / References

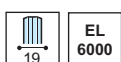

EL
6000



Aluminium anodisé Argent Brossé
Brushed anodised alu. silver



Aluminium anodisé Aninox
Brushed anodised alu. aninox

Profil de serrage pour panneaux fixes avec caches
Glass clamp profile incl. covers

KL005.12

KL005.36

KLA01

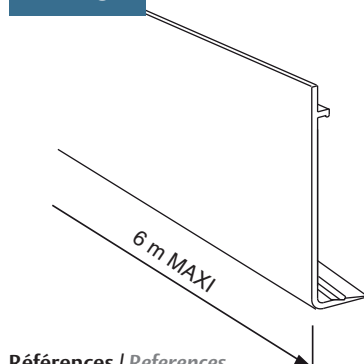

Références / References



EL
6000 Caches pour profil de serrage KL001 - KL002 - KL003 - KL005
Covers for glass clamp profile KL001 - KL002 - KL003 - KL005



Aluminium anodisé Argent Brossé
Brushed anodised alu. silver



Aluminium anodisé Aninox
Brushed anodised alu. aninox

KLA01.12

KLA01.36

